

# **AB Submersible Propeller Pump**

## **OPERATION MANUAL**

### **INTRODUCTION**

Thank you for selecting the Tsurumi AB Submersible Propeller Pump.

This equipment should not be used for applications other than those listed in this manual. Failure to observe this precaution may lead to a malfunction or an accident. In the event of a malfunction or an accident, the manufacturer will not assume any liability. After reading this Operation Manual, keep it in a location that is easily accessible, so that it can be referred to whenever information is needed while operating the equipment.

### **CONTENTS**

1. BE SURE TO READ FOR YOUR SAFETY .....	1
2. PART NAMES.....	4
3. PRIOR TO USE .....	4
4. INSTALLATION .....	5
5. ELECTRICAL WIRING .....	7
6. OPERATION.....	9
7. MAINTENANCE AND INSPECTION.....	11
8. DISASSEMBLY AND REASSEMBLY PROCEDURE .....	13
9. TROUBLESHOOTING .....	14

# 1 BE SURE TO READ FOR YOUR SAFETY

Be sure to thoroughly read and understand the SAFETY PRECAUTIONS given in this section before using the equipment in order to operate the equipment correctly.

The precautionary measures described in this section are intended to prevent danger or damage to you or to others. The contents of this manual that could possibly be performed improperly are classified into two categories: **⚠️ WARNING**, and **⚠️ CAUTION**. The categories indicate the extent of possible damage or the urgency of the precaution. Note however, that what is included under **⚠️ CAUTION** may at times lead to a more serious problem. In either case, the categories pertain to safety-related items, and as such, must be observed carefully.

- **⚠️ WARNING** : Operating the equipment improperly by failing to observe this precaution may possibly lead to death or injury to humans.
- **⚠️ CAUTION** : Operating the equipment improperly by failing to observe this precaution may possibly cause injury to humans and other physical damage.
- **NOTE** : Gives information that does not fall in the WARNING or CAUTION categories.
- **Explanation of Symbols:**



: The  $\triangle$  mark indicates a WARNING or CAUTION item. The symbol inside the mark describes the precaution in more detail ("electrical shock", in the case of the example on the left).



: The  $\circ$  mark indicates a prohibited action. The symbol inside the mark, or a notation in the vicinity of the mark describes the precaution in more detail ("disassembly prohibited", in the case of the example on the left).



: The  $\bullet$  mark indicates an action that must be taken, or instructs how to perform a task. The symbol inside the mark describes the precaution in more detail ("provide ground work", in the case of the example on the left).

## PRECAUTIONS TO THE PRODUCT SPECIFICATIONS

<b>⚠️ CAUTION</b>	
	<p>● Do not operate the product under any conditions other than those for which it is specified. <b>Failure to observe the precaution can lead to electrical leakage, electrical shock, fire, or water leakage, etc.</b></p>



## PRECAUTIONS DURING TRANSPORT AND INSTALLATION

<b>⚠️ WARNING</b>	
	<p>● When transporting the product, pay close attention to its center of gravity and mass. Use an appropriate lifting equipment to lift the unit. <b>Improper lifting may result in the product damage, injury, or death.</b></p>
	<p>● Electrical wiring should be performed in accordance with all applicable regulations in your country. <b>Absolutely provide a dedicated earth leakage circuit breaker and a thermal overload relay suitable for the product (available on the market). Imperfect wiring or improper protective equipment can lead to electrical leakage, fire, or explosion in the worst case.</b></p>
	<p>● Use a power outlet that has a sufficient rating and has been exclusively provided for the pump. <b>If the power outlet is shared with other equipment, it can lead to an abnormal heat of the outlet and can cause fire as a result.</b></p>

### ⚠️ WARNING

● When transporting the product, pay close attention to its center of gravity and mass. Use an appropriate lifting equipment to lift the unit. **Improper lifting may result in the product damage, injury, or death.**



● Install the product properly in accordance with this instruction manual. **Improper installation may result in electrical leakage, electrical shock, fire, water leakage, or injury.**



● Electrical wiring should be performed in accordance with all applicable regulations in your country. **Absolutely provide a dedicated earth leakage circuit breaker and a thermal overload relay suitable for the product (available on the market). Imperfect wiring or improper protective equipment can lead to electrical leakage, fire, or explosion in the worst case.**

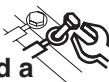



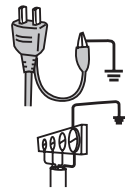



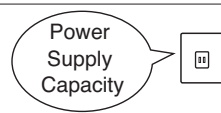





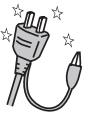



● Provide a secure grounding dedicated for the product. Never fail to provide an earth leakage circuit breaker and a thermal overload relay in your starter or control panel (Both available on the market). **If an electrical leakage occurs due to a product failure, it may cause electrical shock.**





















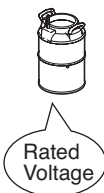



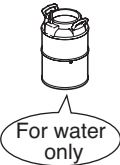

● Use a power outlet that has a sufficient rating and has been exclusively provided for the pump. **If the power outlet is shared with other equipment, it can lead to an abnormal heat of the outlet and can cause fire as a result.**





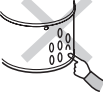







 <b>CAUTION</b>			
	<ul style="list-style-type: none"> <li>● Be sure to provide a ground wire securely. Do not connect the ground wire to a gas pipe, water pipe, lightning rod, or telephone ground wire. <b>Improper grounding could cause electrical shock.</b></li> </ul> 		<ul style="list-style-type: none"> <li>● Prevent a metallic object or dust from sticking to the power plug. <b>Adhesion of foreign object to the plug could cause electrical shock, short-circuit, or fire.</b></li> </ul> 
	<ul style="list-style-type: none"> <li>● Do not scratch, fold, twist, make alterations, or bundle the cable, or use it as a lifting device. <b>The cable may be damaged, which may cause electrical leakage, short-circuit, electrical shock, or fire.</b></li> </ul> 		<ul style="list-style-type: none"> <li>● Do not use the cable, power plug, or power outlet if it is damaged or it is not closely fitted. Connect every conductor of the cable securely to the terminals. <b>Failure to observe this can lead to electrical shock, short-circuit, or fire.</b></li> </ul> 
	<ul style="list-style-type: none"> <li>● Install the discharge pipe securely so that no water leakage may occur. In addition, It is suggested to provide a stand-by pump in case of flooding. <b>Failure to do so may result in damage to nearby walls, floors, and other equipment.</b></li> </ul> 		<ul style="list-style-type: none"> <li>● When the product will be carried by hand, decide the number of persons considering the mass of the product. <b>When lifting up the product, do not attempt to do it by simply bowing from the waist. Use the knees, too, to protect your waist.</b></li> </ul> 
	<ul style="list-style-type: none"> <li>● This pump is neither dust-proof nor explosion-proof. Do not use it at a dusty place or at a place where toxic, corrosive or explosive gas is present. <b>Use in such places could cause fire or explosion.</b></li> </ul> 		<ul style="list-style-type: none"> <li>● If a hose is used for the discharge line, take a measure to prevent the hose from shaking. <b>If the hose shakes, you may be wet or injured.</b></li> </ul> 





## PRECAUTIONS DURING TEST OPERATION AND OPERATION

 <b>WARNING</b>			
	<ul style="list-style-type: none"> <li>● Never try to operate the pump if somebody is present in the pump sump. <b>If an electrical leakage occurs, it can cause electrical shock.</b></li> </ul> 		<ul style="list-style-type: none"> <li>● Never start the pump while it is suspended, as <b>the unit may jerk and could lead to injury.</b></li> </ul> 
	<ul style="list-style-type: none"> <li>● When changing power connection is needed to correct the direction of rotation, be sure to turn off the power supply (earth leakage circuit breaker, etc.), and perform the work after making sure that the impeller has stopped completely. <b>Failure to do so may lead to electrical shock, short-circuit, or injury.</b></li> </ul> 		<ul style="list-style-type: none"> <li>● When inspecting the pump, be sure to turn off the power supply (earth leakage circuit breaker, etc.) so that the pump may not start accidentally. <b>Failure to do so may lead to a serious accident.</b></li> </ul> 
 <b>CAUTION</b>			
	<ul style="list-style-type: none"> <li>● Do not operate the product under any voltage other than described on the nameplate with the voltage tolerance limit within <math>\pm 5\%</math>. If it is operated with a generator, it is strongly suggested not to operate other equipment with the same generator. <b>Failure to observe this caution may cause malfunction and breakdown of the product, which may lead to electrical leakage or electrical shock.</b></li> </ul> 		<ul style="list-style-type: none"> <li>● Do not touch the product with bare hands during or immediate after the operation, as the product may become very hot during operation. <b>Failure to observe this caution may lead to burn.</b></li> </ul> 
	<ul style="list-style-type: none"> <li>● Do not use the product in a liquid other than water. <b>Use in oil, salt water or organic solvents will damage it, which may lead to electrical leakage or electrical shock.</b></li> </ul> 		<ul style="list-style-type: none"> <li>● Do not run the product dry or operate it with its valve (sluice or gate valve) closed, as <b>doing so will damage the product, which may lead to electrical leakage or electrical shock.</b></li> </ul> 





 <b>CAUTION</b>	
	<ul style="list-style-type: none"> <li>Do not use the product for hot or warm liquid over 40°C, as <b>doing so will damage the product, which may lead to electrical leakage or electrical shock.</b></li> </ul> 
	<ul style="list-style-type: none"> <li>Do not allow foreign objects (metal objects such as pins or wires) to enter the suction inlet of the pump. <b>Failure to observe this caution could cause it to malfunction or to operate abnormally, which may lead to electrical leakage or electrical shock.</b></li> </ul> 
	
<ul style="list-style-type: none"> <li>When the product will not be used for an extended period, be sure to turn off the power supply (earth leakage circuit breaker, etc.). <b>Deterioration of the insulation may lead to electrical leakage, electrical shock, or fire.</b></li> </ul>  	

## PRECAUTIONS DURING MAINTENANCE AND INSPECTION





 <b>WARNING</b>	
	<ul style="list-style-type: none"> <li>Absolutely turn off the power supply or disconnect the plug before starting maintenance or inspection. Do not work with wet hands. <b>Failure to observe these cautions may lead to electrical shock or injury.</b></li> </ul>   
	<ul style="list-style-type: none"> <li>In case any abnormality (excessive vibration, unusual noise or odor) is found in the operation, turn the power off immediately and consult with the dealer where it was purchased or Tsurumi representative. <b>Continuing to operate the product under abnormal conditions may result in electrical shock, fire, or water leakage.</b></li> </ul>  
	
<ul style="list-style-type: none"> <li>Do not disassemble or repair any parts other than those designated in the operation manual. If repairs are necessary in any other than the designated parts, consult with the dealer where it was purchased or Tsurumi representative. <b>Improper repairs can result in electrical leakage, electrical shock, fire, or water leakage.</b></li> </ul> 	



 <b>CAUTION</b>	
	<ul style="list-style-type: none"> <li>After reassembly, always perform a test operation before resuming use of the product. <b>Improper assembly can result in electrical leakage, electrical shock, fire, or water leakage.</b></li> </ul>  

## PRECAUTION TO POWER OUTAGE

 <b>WARNING</b>	
	<ul style="list-style-type: none"> <li>In case of power outage, turn off the power supply. <b>The product will resume operation when the power is restored, which presents serious danger to people in the vicinity.</b></li> </ul>   <p style="text-align: right;">power outage</p>

## OTHER PRECAUTION

 <b>CAUTION</b>	
	<ul style="list-style-type: none"> <li>Never use the product for potable water. <b>It may present a danger to human health.</b></li> </ul>  

 <b>CAUTION</b>	
	<ul style="list-style-type: none"> <li>This appliance is not intended for use by persons (including children) with reduced physical, sensory or mental capabilities, or lack of experience and knowledge, unless they have been given supervision or instruction concerning use of the appliance by a person responsible for their safety.</li> <li>Children should be supervised to ensure that they do not play with the appliance.</li> <li>If the supply cord is damaged, it must be replaced by the manufacturer, its service agent or similarly qualified persons in order to avoid a hazard.</li> <li>Pollution of the liquid could occur due to leakage of lubricants.</li> <li>The pump must be supplied through a residual current device (RCD) having a rated residual operating current not exceeding 30 mA.</li> </ul>

## 2 PART NAMES

### Example

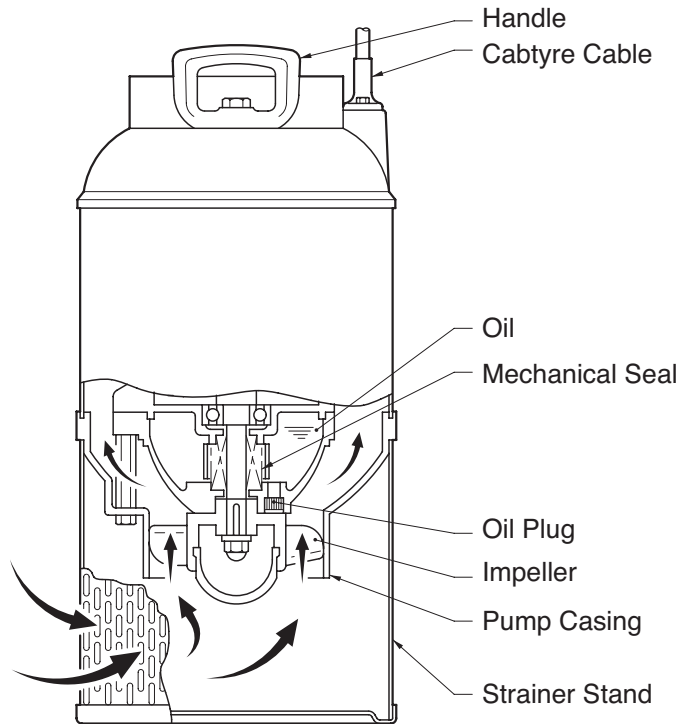

## 3 PRIOR TO OPERATION

After unpacking, verify the contents.

### Product Inspection

Inspect the product for damage during shipment, and make sure all bolts and nuts are tightened properly.

### Specification Check

Check the nameplate of the unit to verify that it is the product that you have ordered. Pay particular attention to its voltage and frequency specifications.

### Example of nameplate

<b>TSURUMI PUMP</b>		<b>SUBMERSIBLE PUMP</b> <small>Built in motor protector</small>	
No.	③	①	②
MODEL	④	⑤	Hz
H MAX.	⑥	m	H MIN.
⊕ Q MAX.	⑧	m <sup>3</sup> /min	DN ⑨
U	⑩	~	⑪
I			⑫
P <sub>2</sub>	⑬	kw	INS.
Wt	⑮	kg	N
	⑯	min <sup>-1</sup>	IP ⑰
	⑱	m	
<b>TSURUMI MFG.CO.,LTD.</b>			
Side View		Top View	
▲ ROTATION		⊙ ROTATION	
XXXXX			

1	Submersible pump	11	Rated voltage
2	Built in motor protector	12	Rated current
3	Serial number	13	Rated output power
4	Model	14	Insulation class
5	Frequency	15	Max. liquid temperature
6	Max. total head	16	Weight without cable
7	Min. total head	17	Speed of rotation
8	Max. flow rate	18	IP degree of protection
9	Discharge bore	19	Max. immersion depth
10	Phase	20	Direction of rotation

**Note:** If you discover any damage or discrepancy, please contact with the Tsurumi dealer from whom you purchased the product or the nearest Tsurumi representative office.

## Accessory Check

Verify that all accessory items are included in the package.  
 Operation Manual..... 1

**Note:** *If you discover any damage or discrepancy in the product, please contact the dealer where this equipment was purchased or the Tsurumi sales office in your area.*

## Product Specifications

**CAUTION** Do not operate this product under any conditions other than those that have been specified.

### Major Standard Specifications

Fluid	Property	River water and Agricultural water ; 0 ~ 40°C
Pump	Impeller	Propeller
	Shaft Seal	Double Mechanical Seal
	Bearing	Shielded Ball Bearing
Motor	Specifications	Dry type Submersible Induction Motor, 2,4-Pole
	Insulation	Class E
	Protection System (built-in)	Circle thermal protector
	Lubricant	Liquid Paraffin VG32
Discharge Connection		Special Screw

## 4 INSTALLATION

**CAUTION**

- Do not use the pump for pumping liquids other than water, such as oil, salt water, or organic solvents.
- The supply voltage should be within  $\pm 5\%$  of the rated voltage.
- The water temperature for operating the pump should be between 0 ~ 40°C. Failure to observe the precautions given above could cause the pump to malfunction, which may lead to current leakage or electrical shock.

**Note:** *To use the pump for a special solution, contact the dealer where it was purchased, or the Tsurumi sales office in your area.*

### Critical Use Pressure

**CAUTION** Do not operate the pump in an area that is exposed to a water pressure that exceeds the values given below.

Applicable Pump	Critical Use Pressure
Models with output of 0.75kW or under	0.2MPa(2kgf/cm <sup>2</sup> ) – discharge pressure during use
Models with output 1.5kW	0.3MPa(3kgf/cm <sup>2</sup> ) – discharge pressure during use

## Preparation for Installation

### Single-phase power supply:

Use a megger to measure the resistance between the tip of the cabtyre cable plug and the ground terminal to verify the insulation resistance of the motor.  
 (This diagram shows a 2-pin plug type.)

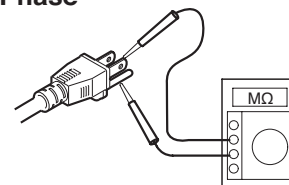

### Three-phase power supply:

Use a megger to measure the resistance between each core of the cabtyre cable and the (green) ground wire to verify the insulation resistance of the motor.

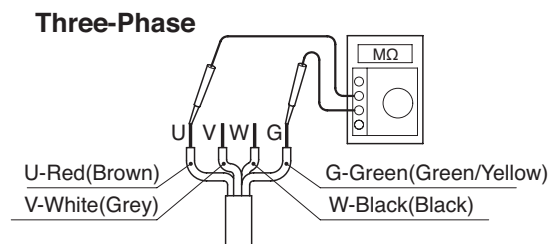

Insulation resistance reference value  
= 20MΩ minimum

**Note:** *The insulation resistance reference value of 20MΩ minimum is based on a new or repaired pump. For reference values of a pump that has already been put into operation, refer to "7. Maintenance and Inspection" of this manual.*

## Precautions During Installation

**WARNING** When installing the pump, be mindful of the pump's center of gravity and weight. If the pump is not suspended properly, the pump may fall and break, which may lead to injury.

**CAUTION** When installing or moving the pump, never suspend the pump by the cable. Doing so will damage the cable, which may cause a current leakage, electrical shock, or fire.

When a hose is used, attach the hose to the screw-on hose coupling as far as it will go, then fasten it securely with the hose bands.

### Using a hose

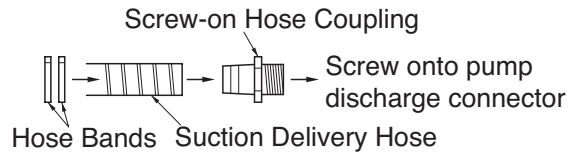

When PVC pipe is used, attach the pipe onto the socket as far as it will go, then bond it with adhesive.

### Using a PVC pipe

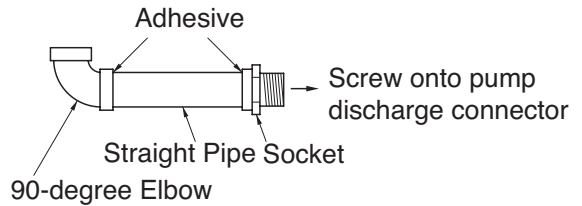

Handle the pump carefully without applying shock to it, such as by dropping it. To suspend the pump, do so manually or by attaching ropes to its handles.

**CAUTION** The rope for suspending the pump during its installation must be of a thickness that accommodates the weight of the pump. When using a chain, make sure that the chain does not become twisted. Failure to observe these precautions could cause the rope or chain to break and the pump to fall and break, which could lead to personal injury.

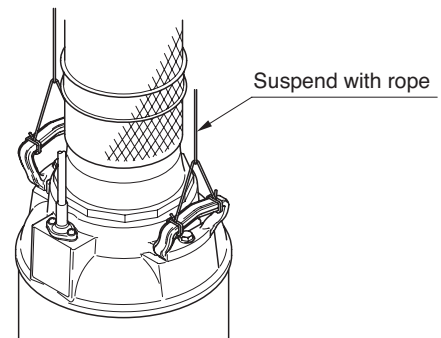

Operate the pump in a location that has a sufficient water level and collects water easily.

**CAUTION** If the pump draws in a large amount of mud, it could cause the pump to wear prematurely and lead to a malfunction, current leakage, and electrical shock.

**Note:** For the water level required for operating the pump, refer to the external dimension drawing, which is provided separately.  
Extend the end of the hose (discharge side) above the water surface. If the end of the hose is submerged in water, it may cause the water to flow back when the pump has been stopped. Conversely, if the end of the hose is located at a level that is lower than the source water surface, water may continue to flow out even after the pump has been stopped.

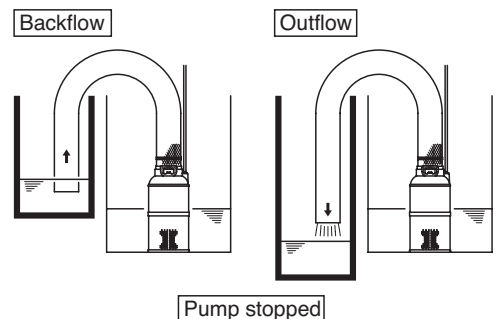

# 5 ELECTRICAL WIRING

## Electrical Wiring Work

- ⚠ WARNING**
- All electrical work must be performed by an authorized electrician, in compliance with local electrical equipment standards and internal wiring codes. Never allow an unauthorized person to perform electrical work because it is not only against the law, but it can also be extremely dangerous.
  - Improper wiring can lead to current leakage, electrical shock, or fire.
  - Absolutely provide a dedicated earth leakage circuit breaker and a thermal overload relay suitable for the pump (available on the market). Failure to follow this warning can cause electrical shock or explosion when the product fails or an electrical leakage occurs.

Operate well within the capacity of the power supply and wiring.

## Grounding

- ⚠ WARNING** Be sure to install the ground wire securely. Failure to observe this precaution could damage the pump and cause current leakage, which may lead to electrical shock.

- ⚠ CAUTION** Do not connect the ground wire to a gas pipe, water pipe, lightning rod, or telephone ground wire. Improper grounding could cause electrical shock.

## Connecting the Power Plug

- ⚠ WARNING** Before inserting the power plug or connecting the wires to the terminal board, make sure that the power supply (i.e. circuit breaker) is properly disconnected. Failure to do so may lead to electrical shock, short, or injury caused by the unintended starting of the pump.

- ⚠ CAUTION** Do not use damaged cable cables, power plugs, or loose power outlets. Failure to observe this precaution could lead to electrical shock, short circuit, or fire.

Follow the diagram on the right to connect the power.

When using a three-prong grounded plug, connect as shown in the drawing.

- ⚠ CAUTION** Be sure to use a dedicated power supply with a ground leakage circuit breaker.

(This diagram shows a 2-pin plug type.)

**Note:** *The shape of the plug may differ from that shown in the illustration.*

When a single-phase power source is used, connect the leads to the control panel terminals as shown in the diagram, making sure they do not become twisted together.

When a three-phase power source is used, connect the leads to the control panel terminals as shown in the diagram, making sure they do not become twisted together.

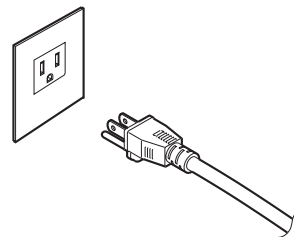

### Single Phase

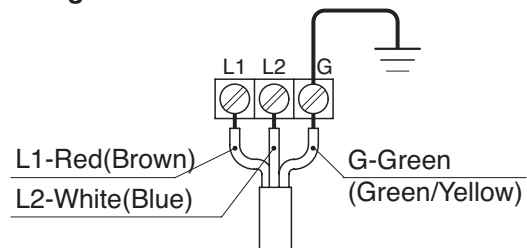

### Three Phase

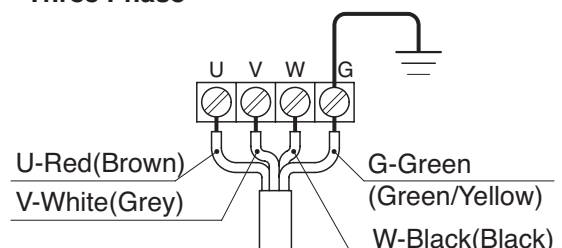



## Motor Protector

The pump is equipped with an internal motor protector.

Circle Thermal Protector:

If a current overload or overheating occurs under the symptoms given below, the motor will stop automatically to protect the motor regardless of the water level at the time of operation.

In this type of motor protector, the motor will automatically restart after cooling down. If the motor is stopped by protector tripping, turn off the power supply first, and disconnect the cables from the power terminals. After this, make sure to eliminate the cause of the problem, such as the following:

- Extreme fluctuation of power supply voltage
- Pump operated under overload condition
- Pump operated at open phase or binding condition

**WARNING** If repair or maintenance is attempted with cables connected to power supply, unintended automatic restarting of the motor may cause human injury.

**Note:** After the motor protector has tripped, the motor automatically resumes its operation. Therefore, make sure to disconnect the cable from the terminal board or the power outlet, and eliminate the cause of the problem.

Do not operate the pump at unusually low head, or with the impeller clogged with debris. Doing so will not only prevent the pump from attaining its full potential, but may also generate abnormal noise and vibration and damage the pump.

## Electrical Circuit Diagrams

### Power Supply: Single-Phase

■ 100-120V

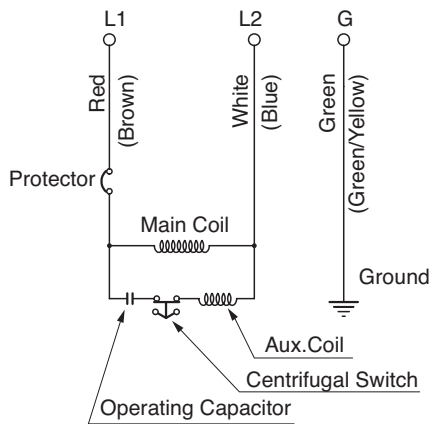

■ 200-240V

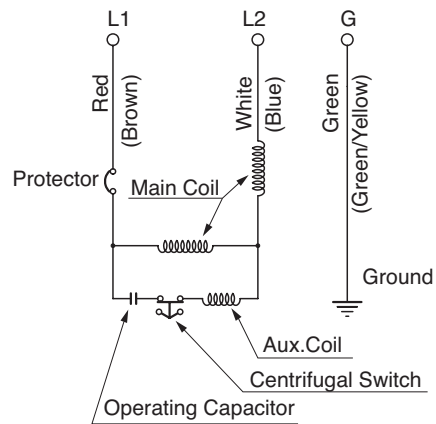

### Power Supply: Three-Phase

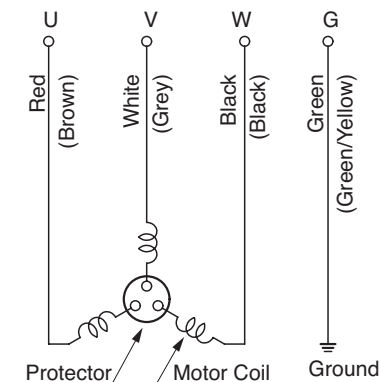

## 6 OPERATION

### Prior to Operation

- (1) Once again, check the nameplate of the pump to verify that its voltage and frequency are correct.

**CAUTION** Improper voltage and frequency of the power supply will prevent the pump from attaining its full potential, and may also damage the pump.

**Note:** Verify the specs on the pump's nameplate.

- (2) Check the wiring, power supply voltage, the capacity of the ground leakage circuit breaker, and the insulation resistance of the motor.

■ Insulation resistance reference value = 20MΩ minimum

**Note:** The insulation resistance reference value of 20MΩ minimum is based on a new or repaired pump. For reference values of a pump that has already been put into operation, refer to "Maintenance and Inspection".

- (3) Adjust the setting of the thermal relay (i.e. 3E relay) to the pump's rated current.

**Note:** Verify the rated current on the pump's nameplate.

### Trial Operation (three-phase models only)

**WARNING** Never start the pump while it is suspended, as the pump may jerk and cause a serious accident involving injury.

- (1) Operate the pump for a short time (1 to 2 seconds) and verify the direction of the rotation of the impeller. Observe the pump unit from above, and if its recoil is in the counterclockwise direction, the direction of its rotation is correct.

**CAUTION** Make sure to check the pump's direction of rotation with the pump exposed to the atmosphere. Operating the pump in reverse while it is submerged in water will damage the pump, which may lead to current leakage and electrical shock.

- (2) To reverse the rotation, the following countermeasures must be taken.

**WARNING** Before changing the connections for reverse rotation, make sure that the power supply (i.e. circuit breaker) is properly disconnected and that the impeller has stopped completely. Failure to observe this may lead to electrical shock, short, or injury.

#### COUNTERMEASURE

Direct-on-line starting  
Interchange any two of the three wires designated U, V, and W, respectively.

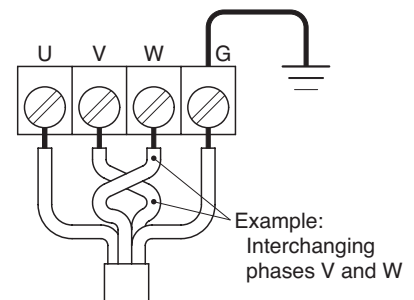

- (3) Connect the pump to the pipe and submerge it in water.
- (4) Operate the pump for a short time (3 to 10 minutes) and perform the following checks:

Using an AC ammeter (clamp), measure the operating current at the phases U, V, and W that are connected to the terminal board.

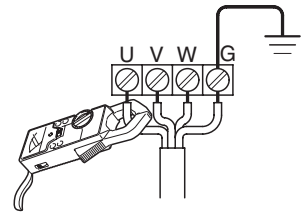

#### COUNTERMEASURE

Because an overload condition may be present at the pump motor if the operating current exceeds the rated current, follow the instructions in section "4. Installation" to operate the pump in the correct manner.

Using an AC voltmeter (tester), measure the voltage at the terminal board.

■ Power supply voltage tolerance = within  $\pm 5\%$  of the rated voltage

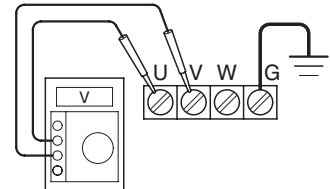

#### COUNTERMEASURE

If the power supply voltage deviates from the tolerance value, the cause of the deviation may be the capacity of the power supply or the extension cable that is used. Refer to section "5. Electrical Wiring" to operate the pump in the correct manner.

**CAUTION** In case the pump exhibits an abnormal condition (such as a considerable amount of vibration, noise, or smell), disconnect the power supply immediately and contact the dealer where you purchased the equipment, or Tsurumi's sales office in your area. If the pump continues to be used in the abnormal state, it may cause current leakage, electrical shock, or fire.

- (5) Proceed with the normal operation if no abnormal conditions are found during the trial operation.

### Operation

**WARNING** The pump unit may be extremely hot during operation. To prevent burns, do not touch the pump unit with bare hands during or after the operation.

Pay attention to the water level during the pump operation. The pump will become damaged if it is allowed to operate dry.

Due to an overload operation or a pump malfunction, if the motor protector trips to stop the pump, make sure to eliminate the cause of the problem before restarting.

A frequent ON/OFF will shorten the lifetime of the pump.

To operate a submersible pump (including automatic operation), set the water level so that the pump will operate up to a maximum of 5 ~ 6 times per hour.

**Note:** A large amount of amperage flows when a submersible pump is started, causing the temperature of its windings to rise rapidly. Beware that a frequent stop-and-go operation of the pump will accelerate the deterioration of the insulation of the motor windings and thus affect the use life of the motor.

### Operating Water Level

**CAUTION** Do not operate the pump at the lowest water level longer than 30 minutes, as it could damage the pump, causing current leakage and electrical shock. For details on the lowest water level, refer to the dimension drawing, which is provided separately.

# 7 MAINTENANCE AND INSPECTION

Regular maintenance and inspection are indispensable to maintaining the pump's performance. If the pump behaves differently from its normal operating condition, refer to section "9. Troubleshooting" and take appropriate measures at an early stage. We also recommend that you have a spare pump on hand for an emergency.

## Prior to Inspection



### WARNING

Make sure that the power supply (i.e. circuit breaker) is disconnected and disconnect the cable from the power outlet or remove it from the terminal board. Failure to do so may cause electrical shock or unintended starting of the pump, which may lead to serious accidents.

#### (1) Washing the Pump

Remove any debris attached to the pump's outer surface, and wash the pump with tap water. Pay particular attention to the impeller area, and completely remove any debris from the impeller.

#### (2) Inspecting the Pump Exterior

Verify that there is no damage, and that the bolts and nuts have not loosened.

**Note:** If the pump must be disassembled for repair due to damage or loose bolts or nuts, contact the dealer where it was purchased, or the Tsurumi sales office in your area.

## Daily and Periodic Inspection

Interval	Inspection Item
Daily	Measuring the operating current ■ To be within the rated current Measuring the power voltage ■ Power supply voltage tolerance = within $\pm 5\%$ of the rated voltage
Monthly	Measuring the insulation resistance ■ Insulation resistance reference value = 1M $\Omega$ minimum [NOTE] The motor must be inspected if the insulation resistance is considerably lower than the last inspection.
Half-yearly	Inspecting oil (models with 0.75kW maximum power output) ■ 1,500 hours or 6 months, whichever comes first
Yearly	Inspecting oil (models with 1.5kW power output) ■ 6,000 hours or 12 months, whichever comes first Changing oil (models with 0.75kW maximum power output) ■ 3,000 hours or 12 months, whichever comes first Changing the mechanical seal (models with 0.75kW maximum power output) [NOTE] The inspection and replacement of the mechanical seal requires specialized equipment. To have this operation performed, contact the dealer where this equipment was purchased, or the Tsurumi sales office in your area.
Once every 2 years	Changing oil (models with 1.5kW power output) ■ 9,000 hours or 24 months, whichever comes first Changing the mechanical seal (models with 1.5kW power output) [NOTE] The inspection and replacement of the mechanical seal requires specialized equipment. To have this operation performed, contact the dealer where this equipment was purchased, or the Tsurumi sales office in your area.
Once every 2 to 5 years	Overhaul ■ The pump must be overhauled even if the pump appears normal during operation. Especially, the pump may need to be overhauled earlier if it is used continuously. [NOTE] To overhaul the pump, contact the dealer where it was purchased, or the Tsurumi sales office in your area.

**Note:** Refer to section "Oil Inspection and Change Procedures" below for further detail.

**Note:** In case the pumping liquid contains oil, paint, or slurry, it may cause the swelling of cable jacket or abrasion of the mechanical seal's sealing face, which will result in the pump fault, it is strongly recommended to inspect earlier.

## Storage

If the pump will not be operated for a long period of time, pull the pump up, wash the pump, allow it to dry, and store it indoors.

**Note:** For reinstallation, be sure to perform a trial operation before putting the pump into operation.

If the pump remains immersed in water, operate it on a regular basis (i.e. once a week).

## Oil Inspection and Changing Procedures

### Inspecting Oil

Inspect the oil as follows:

- (1) Using a screwdriver, remove the Phillips screws and plain washers to remove the strainer stand.
- (2) Remove the hex nut and the spring washer to remove the pump casing, outer cover, and the upper and lower square packings.
- (3) Remove the impeller thread protection cap with a screwdriver, and the hex nut with a box wrench. Then, remove the impeller and the impeller adjusting washer.
- (4) Remove the oil plug with a hex key wrench.
- (5) Stand the unit upright and drain the oil. If the drained oil appears milky or intermixed with water, a likely cause is a defective shaft sealing device (i.e. mechanical seal), which requires that the pump be disassembled and repaired.

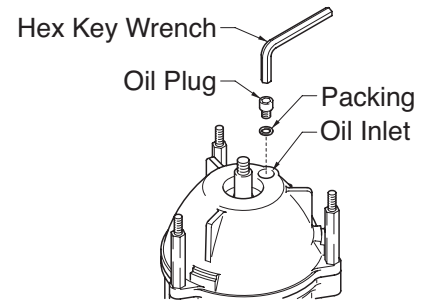

Specified Oil: Liquid Paraffin VG32		Unit : ml
Applicable Model		Specified Volume
Model with 0.4 ~ 0.75kW power output		160
Model with 1.5kW power output		600

### Changing Oil

Remove the oil plug and drain the oil completely. Pour a specified volume of oil into the oil filler inlet.

**Note:** The drained oil must be disposed of properly to prevent it from being released into the sewer or rivers. The packing or the O-ring for the oil plug must be replaced with a new part at each oil inspection and change.

## 8

## DISASSEMBLY AND REASSEMBLY PROCEDURE

## Prior to Disassembly and Reassembly

**WARNING**

Before disassembling and reassembling the pump, be sure that the power supply (i.e. circuit breaker) is disconnected, and remove the cabtyre cable from the outlet or the terminal board. Do not connect or disconnect the power plug with a wet hand, in order to prevent electrical shock. Do not perform an activation test (to check the rotation of the impeller) during disassembly and reassembly. Failure to observe this precaution could lead to a serious accident, including injury.

This section explains the disassembly and reassembly processes that are involved up to the replacement of the impeller itself. Operations involving the disassembly and reassembly of the sealing portion (i.e. mechanical seal) and of the motor require a specialized facility including vacuum and electrical test equipment. For these operations, contact the dealer where this equipment was purchased, or the Tsurumi sales office in your area.

### Disassembly Procedure (Model 150AB41.5)

- (1) Removing the strainer stand  
Using a screwdriver, remove the Phillips screws and plain washers to remove the strainer stand.
- (2) Removing the pump casing and outer cover  
Remove the hex nut and the spring washer to remove the pump casing, outer cover, and the square packings.
- (3) Removing the impeller  
Remove the impeller thread protection cap with a screwdriver and the hex nut with a box wrench. Then, remove the impeller and the impeller adjusting washer.

### Disassembly Diagram (Model 150AB41.5)

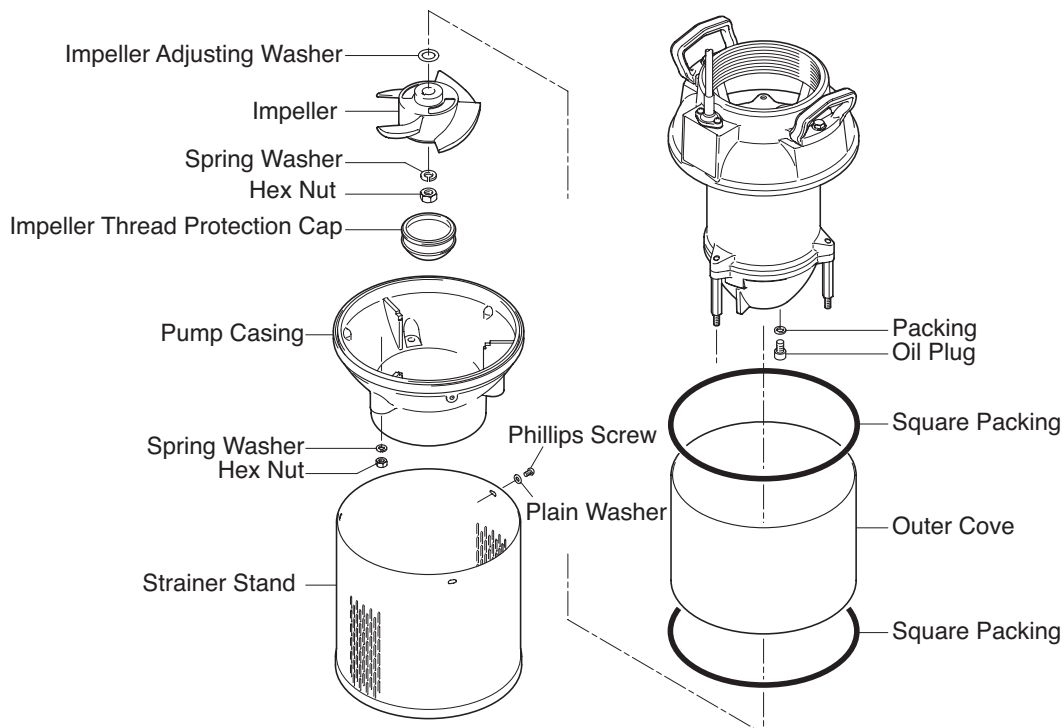

### Reassembly Procedure

Observe the precautions given below and reassemble the unit in the reverse order of disassembly.

**Note:** Make sure to pour in the specified amount of oil before reassembly. Replace the packings with new ones. If there are other parts that are worn or damaged, also replace them with new ones. When installing the outer cover, do not forget to also install the upper and lower square packings.

After installing the impeller, make sure that it rotates smoothly.

## 9 TROUBLESHOOTING

**⚠ WARNING** To prevent serious accidents, disconnect the power supply before inspecting the pump.

Read this Operation Manual carefully before requesting repair. After re-inspecting the pump, if it does not operate normally, contact the dealer where this equipment was purchased, or the Tsurumi sales office in your area.

Problem	Possible cause	Countermeasure
Pump fails to start.	(1) No proper power is supplied (i.e. power outage). (2) Open circuit in cabtyre cable or poor connection. (3) Foreign matter is wedged in the propeller, causing the motor protector to trip.	(1) Contact the electric power company or an electrical repair shop. (2) Check whether there is an open circuit in the cabtyre cable or wiring. (3) Inspect the pump and remove the debris.
Pump starts but stops immediately, causing the motor protector to trip.	(1) Foreign matter is wedged in the impeller or the pump casing is filled with mud. (2) The voltage is too low. (3) A 50Hz pump is used at 60Hz. (4) The pump has been operated for a long time with its strainer stand clogged. (5) The motor is faulty. (6) The pump is drawing in too much mud.	(1) Remove the strainer stand, remove the debris, and spin the impeller by hand. (2) Provide the rated voltage or use an extension cable that meets the specifications. (3) Check the nameplate and replace the pump. (4) Remove the debris from the strainer stand. (5) Repair the motor or replace it with a new one. (6) Place a concrete block under the pump to prevent the pump from drawing in excess mud.
The pumping volume is low.	(1) The impeller is worn. (2) The hose is clogged or kinked at its midspan. (3) The strainer stand is clogged or is buried. (4) The motor rotates in reverse.	(1) Replace the impeller. (2) Minimize the bends of the hose, and if the pump is used in a dusty area, place it inside a mesh basket during operation. (3) Remove the debris from the strainer stand. Place a concrete block under the pump to prevent the pump from drawing in excess mud. (4) Change the power connection.
The pump generates vibration or noise.	(1) The pipe support is loose. (2) Motor bearings are damaged.	(1) Secure the pipe support. (2) Replace the motor bearings.

The following information is required when ordering repairs or making other inquiries.

Product model	
Manufacturing number	
Purchase date	
Remarks	

### Disposal of Product

Properly dispose of the product by disassembling it, presorting the contents, and sending them to the waste material treatment site.